

Article number: 12307100050110
Description: KLEE-coil 307 100 050.110
M5 Hardened/zinc-plated Blue

Measures

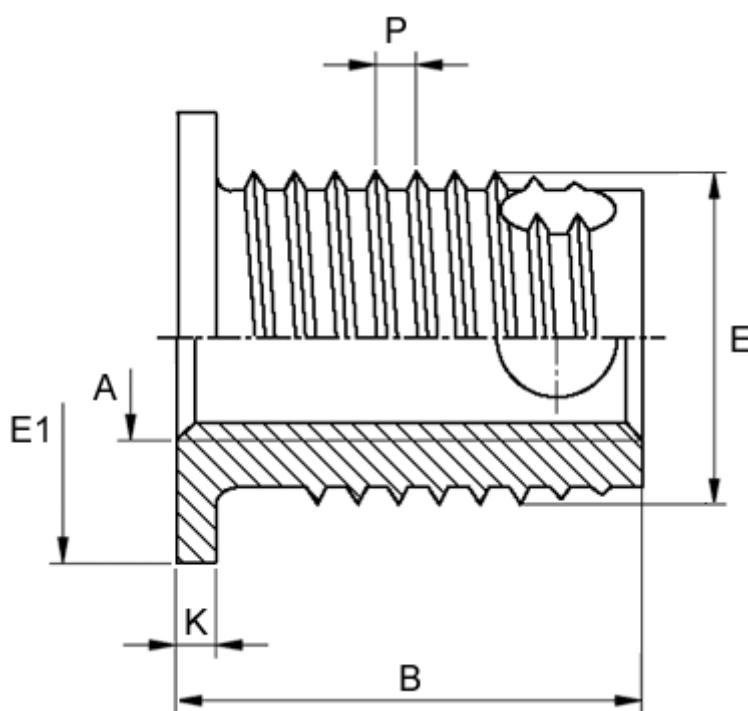

Female thread A	= M5
Flange diameter E1	= 11
Flange height	= 1.0
Length B	= 8.0
Male thread E	= 8
Min hole depth blind hole	= 9
Thread pitch P	= 1.00
Type	= 307 100 050 ...